

# SENIOR DESIGN DAY

**MAY 3 AT MONTEZUMA HALL**

**1:30 - 4:00 PM**

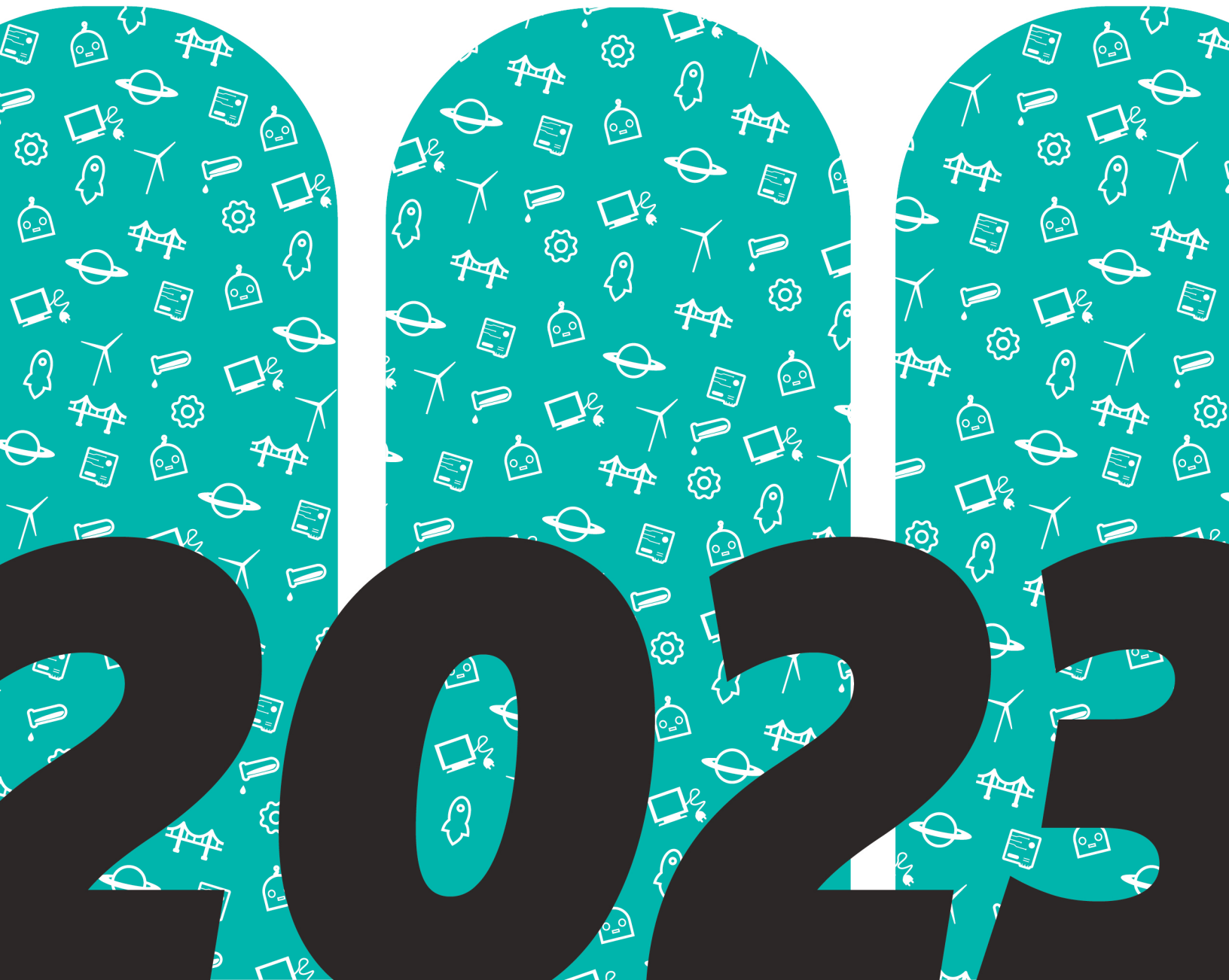



# 2023 Design Day Teams Table of Contents

## Aerospace Engineering

1	Atreides Astronautics	4	Cosmos Corp	7	SDSU Silver Arrow	10	Astraios Technologies
2	Project Mothership	5	Pew! Aerospace	8	North American Aero	11	Ram Drag Aerospace
3	Aztec Aerospace Design	6	PumpWorks	9	The Plane Company		

## Civil, Construction, & Environmental Engineering

12	Arrow Engineering Co. (Team 11)	21	Schiit Works Engineering (Team 02)	30	Seaside Engineering (Team 15)
13	MIP Construction (Team 01)	22	JTI Builders (Team 22)	31	AFJ Engineering (Team 08)
14	GREENCO Engineering (Team 04)	23	Cove Consulting (Team 03)	32	SAFE Engineering (Team 13)
15	Aztec Prophets Engineering (Team 12)	24	Springs Associates (Team 24)	33	DIME Engineering (Team 05)
16	Kodac Design (Team 10)	25	KABS Engr. & Solid Waste Management (Team 26)	34	PILK Engineering (Team 16)
17	Costa Ulan Engineers (Team 20)	26	Phyto-Sea Sustainable Engineering (Team 27)	35	CGJJ Engineering Solutions Inc. (Team 18)
18	Charisma Consultants (Team 21)	27	VACKZ Engineering (Team 19)	36	SDB Engineering (Team 14)
19	R.D.S. Co. (Team 07)	28	Lancaster Co. (Team 25)	37	MASA Civil & Construction Development Inc. (Team 23)
20	MAGUS CONSULTANTS, INC. (Team 06)	29	Bauen International (Team 17)	38	eTron Engineering (Team 09)

## Electrical & Computer Engineering

39	The VU-inator	41	Navi	43	OxySquad
40	The Synthesizers	42	Signal Sleuths	44	TuneTech

## Mechanical Engineering and Electrical & Computer Engineering

45	Autoclox	50	Vulcan	55	Argus III
46	Motorvators	51	LUV Engineering	56	EZ Drive
47	Team Bondi	52	Team Maverick	57	Granola To Go
48	HAFNA	53	S.C.A.N. Robotics	58	Mechanical Assemble Display Automation (MADA)
49	Soteria	54	A.R.M.P.I.T.		

## Mechanical Engineering

59	Team Spray 'n Prey	67	Hephaestus	75	Under Pressure
60	Team Sprinter	68	Team Dextech	76	All Brakes No Gas
61	Turbine Titans	69	Proplane	77	Team Poseidon Green Solutions
62	Pacific Turbines	70	Spin It to Win It	78	Electric Makos
63	ChargeOne+	71	Diabeating Diabetes	79	Mirror Mirror
64	Team Benchwarmers	72	Team Nexus	80	Sun Tilt
65	Reapers	73	Plane and Not-So-Simple		
66	Recycruncher	74	Hot End Aeronautics		

# Design Day 2023 Directory

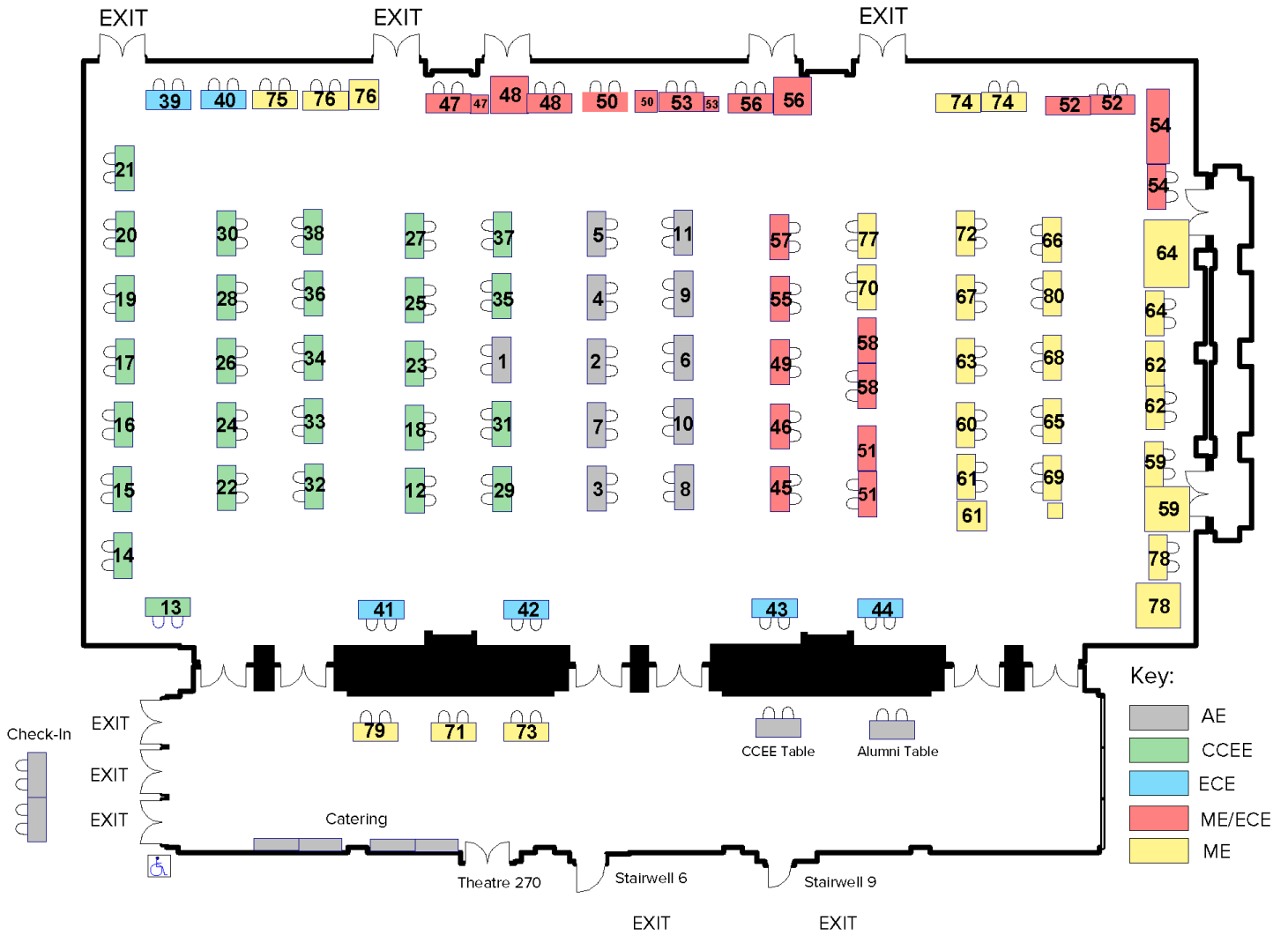



# TABLE OF CONTENTS *Click a header to navigate!*

<b>Thank You to Our Sponsors</b>	<b>8</b>
<b>2023 Design Day Faculty</b>	<b>12</b>
<b>Philanthropic Support</b>	<b>15</b>
<b>Aerospace Engineering &gt;&gt;&gt;</b>	<b>16</b>
<p>AE499: Research Study - <b>Electric Centrifugal Pump</b>                  Astraios Technologies - <b>Project Elysium</b>  <i>Sponsored by SDSU Space Lab - AE</i></p> <p>Atreides Astronautics - <b>Removal of Debris in Earth Orbit (RODEO)</b>  <i>Sponsored by SDSU Space Lab - AE</i></p> <p>Aztec Aerospace Design - <b>AIAA Hybrid Turboprop Aircraft Design</b></p> <p>Cosmos Corp - <b>Long Term Lunar Base</b>  <i>Sponsored by SDSU Space Lab - AE</i></p> <p>North American Aero - <b>Skybeam: Supersonic Business Jet</b></p> <p>Pew! Aerospace - <b>16-Psyche Probe Autonomous Lander and Drill</b>  <i>Sponsored by SDSU Space Lab - AE</i></p> <p>Project Mothership - <b>Spirit of Katz</b></p> <p>RamDrag Aerospace - <b>Solar Gravitational Lens Telescope</b>  <i>Sponsored by SDSU Space Lab - AE</i></p> <p>SDSU Silver Arrow - <b>Advanced Pilot Trainer Jet</b></p> <p>The Plane Company - <b>Flying Vehicle 50</b></p>	
<b>Civil, Construction &amp; Environmental Engineering &gt;&gt;&gt;</b>	<b>20</b>
<p>AFJ Engineering (Team 08) - <b>Carroll Canyon Road Extension</b>  <i>Sponsored by Dokken Engineering</i></p> <p>Arrow Engineering Co. (Team 11) - <b>UCSD Pepper Canyon East Housing Development</b></p> <p>Aztec Prophets Engineering (Team 12) - <b>UCSD Pepper Canyon East Housing Development</b></p> <p>Bauen International (Team 17) - <b>UCSD Hillcrest Hospital Development</b></p> <p>CGJJ Engineering Solutions INC. (Team 18)- <b>UCSD Hillcrest Hospital Development</b></p> <p>Charisma Consultants (Team 21) - <b>Easter Municipal Water District Reservoir Tank</b>  <i>Sponsored by Richard Brady &amp; Associates, Inc.</i></p> <p>Costa Ulan Engineers (Team 20) - <b>Encinitas Community Park Stormwater Reuse</b></p> <p>Cove Consulting (Team 03) - <b>Vista Inland Rail Trail</b>  <i>Sponsored by SANDAG &amp; QIC</i></p> <p>DIME Engineering (Team 05) - <b>San Diego River Bridges</b></p> <p>eTron Engineering (Team 09) - <b>Carroll Canyon Road Extension</b>  <i>Sponsored by Dokken Engineering</i></p> <p>GREENCO Engineering (Team 04) - <b>Vista Inland Rail Trail</b></p> <p>JTI Builders (Team 22) - <b>Eastern Municipal Water District Reservoir Siting &amp; Civil</b>  <i>Sponsored by Richard Brady &amp; Associates, Inc.</i></p> <p>Engineering &amp; Solid Waste Management (Team 26) - <b>Encina Digester 4 Rehabilitation</b>  <i>Sponsored by Encina Wastewater Authority</i></p> <p>Kodac Design (Team 10) - <b>UCSD Pepper Canyon East Housing Development</b></p>	



**HAFNA - Horn Antenna Fixture for Network Analyzer***Sponsored by Laird***LUV Engineering - Automated UV-C Disinfecting Oven***Sponsored by Masimo***Mechanical Assembly Display Automation (MADA) - Mechanical Assembly Display Automation***Sponsored by General Atomics - Aeronautical Systems***Motorvators - Grounded Low Voltage Power Supply for an Electric Formula SAE Race Car***Sponsored by Aztec Electric Racing***S.C.A.N. Robotics - Coordinated Multi-Robots for Planetary Exploration***Sponsored by SDSU Mechanical Engineering Department***Soteria - UAV Payload Deployment for Search and Rescue***Sponsored by Northrop Grumman***Team Bondi - Automated Pouch Opener/Presenter***Sponsored by Masimo***Team Maverick - Automated Taxi / Parking Enabling Technology***Sponsored by General Atomics***Vulcan - NASA Artemis 2023 Lunabotics - Robotic Mining Challenge***Sponsored by SDSU & NASA***Mechanical Engineering >>>****All Brakes No Gas - Regenerative Braking System for An Electric Formula SAE Racecar***Sponsored by Aztec Electric Racing***ChargeOne+ - Battery Box Design for an Electric Formula SAE Race Car***Sponsored by Aztec Electric Racing***Diabeating Diabetes - Automated Applicator Reliability Test Fixture***Sponsored by Dexcom***Electric Makos - Electro-Mechanical Continuously Variable Transmission***Sponsored by Aztec Baja SAE***Hephaestus - Thermoelectric Power Generator***Sponsored by SDSU Mechanical Engineering Department***Hot End Aeronautics - 3D Printed Aircraft Competition***Sponsored by SDSU & Erika Binder, Alumni - CSULA***Mirror Mirror - Multilayer Mirror Sample Holder with Cooling***Sponsored by ASML***Pacific Turbine - Design and Test of Savonius Wind Turbines Equipped with Flexible Blades***Sponsored by SDSU Mechanical Engineering Department***Plane and Not-So-Simple - 3D Printed Aircraft Competition***Sponsored by SDSU & Erika Binder, Alumni - CSULA***Proplane - NASA Blue Skies Clean Aviation Energy Competition***Sponsored by SDSU Mechanical Engineering Department***Reapers - Airborne Payload Enclosure***Sponsored by General Atomics***Recycruncher - Recycle Cruncher***Sponsored by Aous Mohammad, Independent Entrepreneur***Spin It to Win It - Rotating Disk Cellular Solid Testing Apparatus***Sponsored by SDSU Mechanical Engineering Department*







# THANK YOU TO OUR SPONSORS







# THANK YOU TO OUR SPONSORS

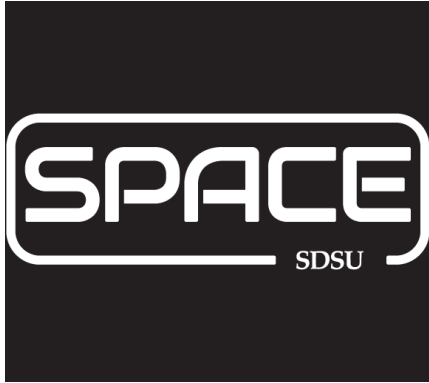



## 2023 DESIGN DAY FACULTY

### Aerospace Engineering >>>



**Ahmad Bani Younes, Ph.D., Associate Professor**

*abaniyounes@sdsu.edu*

Dr. Bani Younes is an Associate Professor in the Department of Aerospace Engineering. He received an M.S. in Aerospace Engineering from the University of Dayton and a Ph.D. in Aerospace Engineering from Texas A&M University. Dr. Bani Younes' research interests lie in the areas of optimization, estimate and control applications in dynamical systems; guidance, navigation, and astronautics; space robotics and autonomous UAS; and algorithm development. After his successful achievement in building the Spacecraft Platform for Astronautics & Celestial Emulation (SPACE) at Khalifa University, Dr. Bani Younes is currently developing a Space GNC and astronautics laboratory at SDSU. It aims to be a 6DOF facility that supports comprehensive studies and hardware experiments for sensing, guidance, dynamics, and control of space operations in an operationally relevant environment. The lab conducts research in robotic sensing and control with an aim to enhance the fields of proximity operations, human-robot interaction, stereo vision, swarm robotics, and autonomous aerial vehicles.



**Geoffrey S. Butler, Lecturer**

*gbutler@sdsu.edu*

Mr. Butler is a working professional aerospace engineer involved in the design and analysis of aircraft for both military and civil applications. He has over 40 years of experience in the aerospace industry and has contributed to the development of vehicles ranging from cruise missiles, to unmanned aircraft, to hypersonic vehicles, as well as launch vehicles. He is an Associate Fellow of the American Institute of Aeronautics and Astronautics (AIAA) and is a member of the AIAA Missile Systems Technical Committee. He has been a lecturer teaching aerospace engineering courses at SDSU including Dynamics, Astrodynamics, Stability and Control, and Aerospace Engineering Applications (AE 460) for over 25 years, and applies a thorough yet practical, applied engineering approach. He was awarded the AIAA Outstanding Teacher award in 2015.

# Civil, Construction & Environmental Engineering >>



**Mark Filanc, PE, Lecturer**

*[mfilanc@filanc.com](mailto:mfilanc@filanc.com)*

Mr. Filanc is the CEO of J.R. Filanc Construction Company Inc. and has over 40 years of experience in water/wastewater design and construction, as well as extensive expertise in all areas of project management. He is a registered professional engineer in the State of California and has been designated as a Design-Build Professional in Design-Build Institute of America's (DBIA) charter group for lifetime experience. He is past chairman and current member of DBIA's Water Committee, past President of the San Diego Chapter of AGC, and an instructor at the national level for AGC's Supervisory Training Program. Mark also serves on the SDSU College of Engineering Dean's Advisory Board and the Department of CCEE Industry Advisory Board. Mark holds a Bachelor of Science degree in Environmental Engineering/Water from California Polytechnic State University, San Luis Obispo, and a Master of Science degree in Civil Engineering, specializing in Construction Management, from Stanford University.



**James R. Haughey, PE, MBA, LEED AP, ENV SP, Lecturer**

*[jrhaughey@mbakerintl.com](mailto:jrhaughey@mbakerintl.com)*

Mr. Haughey is Vice President with Michael Baker International in San Diego, California. Jim has over 30 years of experience in Design-Build with an emphasis in public social infrastructure, military engineering, healthcare, aviation, and school development. Jim has a BS in Civil Engineering (BSCE) from San Diego State University and has an MBA from the University of Phoenix. Jim is a Past President of APWA and serves on several industry boards including Society of American Military Engineers (SAME), ACE Mentorship San Diego, Design Build Institute of America (DBIA), SDSU College of Engineering Dean's Advisory Board, and Chair of SDSU Civil, Construction and Environmental Engineering Industry Advisory Board.



**Jeremy LaHaye, PE, Lecturer**

*[jeremy.lahaye@tylin.com](mailto:jeremy.lahaye@tylin.com)*

Mr. LaHaye is a bridge engineer at T.Y. Lin International with over 20 years of experience in roadway, highway, and structure design including Project Initiation Documents, plans, specifications, and estimate, and construction inspection. He has experience with large scale signature bridge projects, as well as conventional state DOT bridge projects. He currently serves as Vice-Chair for the SDSU Civil, Construction and Environmental Engineering Advisory Board and is the SD ASCE Practitioner Advisor to the SDSU ASCE Chapter. He graduated from San Diego State University in 2001 and was extensively involved in ASCE.



**John Prince, PE, QSD, Lecturer**

*[jprince@delanegroup.com](mailto:jprince@delanegroup.com)*

Mr. Prince is Co-Owner/Vice President of DELANE Engineering with over 20 years of Site Civil Engineering and Site BIM Experience. John has been teaching at SDSU for over 12 years with 2 courses; Intro to Civil and Senior Design, and also serves on the CCEE Industry Advisory Board. John's initial goal and continued passion for teaching at SDSU is to enhance the industry involvement, helping bridge the gap between academia and profession and prepare students for their careers. John is an alumnus of SDSU where he met his wife (also a Civil Engineer). They have two children (both girls) who are very active skiers and enjoy the mountains.

## Electrical & Computer Engineering >>>



**Barry L. Dorr, PE, Lecturer**

*bdorr@sdsu.edu*

Mr. Barry Dorr is a full-time lecturer in SDSU's Department of Electrical and Computer Engineering. Prior to that he worked for San Diego Electronics companies for 35 years as design engineer and project manager. Between 1995 and 2006 he owned a small product development firm creating digital radios, control systems and audio systems for local manufacturers. He holds eight patents for various communication, control, and calibration systems. Professor Dorr earned a BSEE from California State Polytechnic University, San Luis Obispo and a MSEE from SDSU. He is a registered Professional Engineer in the State of California. Professor Dorr's Senior Design course (EE/COMPE 496) emphasizes practical applications of the fundamentals taught in the ECE curriculum, completed within a framework of industry-standard project management practices and personal/team ethics. Professor Dorr regularly does his own "Senior Design" projects to motivate his students and provide real-world examples for the course.

## Mechanical Engineering >>>



**Scott Shaffar, Ph.D., Lecturer**

*sshaffar@sdsu.edu*

Dr. Scott Shaffar is responsible for the development and implementation of the San Diego State University Mechanical Engineering Senior Design Capstone program (ME 490) including course content and program management through all phases from project definition to final system demonstration. This program includes project management, system engineering, research, ideation, detailed design, engineering analysis, fabrication, assembly, test, and customer delivery. Previously, Dr. Shaffar retired from Northrop Grumman Corporation after a 34-year career. In his assignment at retirement, Dr. Shaffar served as a senior director for Northrop Grumman Aerospace Systems, a premier provider of manned and unmanned aircraft, space systems and advanced technologies critical to our nation's security. Dr. Shaffar earned a Bachelor of Science in aerospace engineering from the California State Polytechnic University, Pomona, and a master's and doctorate in mechanical and aerospace engineering from the University of California at Irvine. He is a member of the American Society of Quality, Society of Automotive Engineering, and the American Society of Mechanical Engineers.

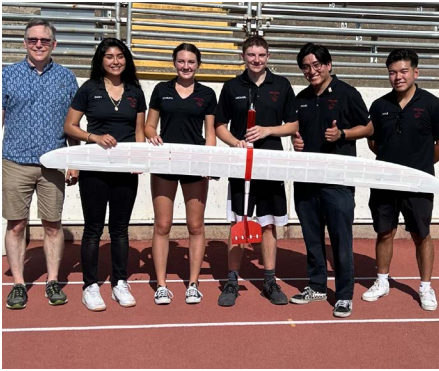

**GIVE TODAY TO THE COLLEGE OF ENGINEERING**

Your generous donor support helps to champion the continued success and growth of the College.

**SPONSOR Senior Design Projects**  
**SUPPORT Student Scholarships**  
**FUND Faculty Named Positions**  
**EXPAND Research Opportunities**  
**ADVANCE Diversity and Inclusion in Engineering**



The College of Engineering is grateful for all those who provide philanthropic support!

If you are interested in supporting the College of Engineering, Contact Kate Carinder, Senior Director of Development at

**[kcarinder@sdsu.edu](mailto:kcarinder@sdsu.edu)**

*The Campanile Foundation | Tax ID 33-0868418*  
[campaign.sdsu.edu/engineeringfund](http://campaign.sdsu.edu/engineeringfund)

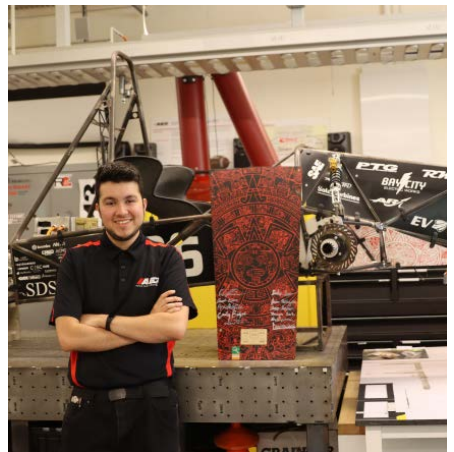
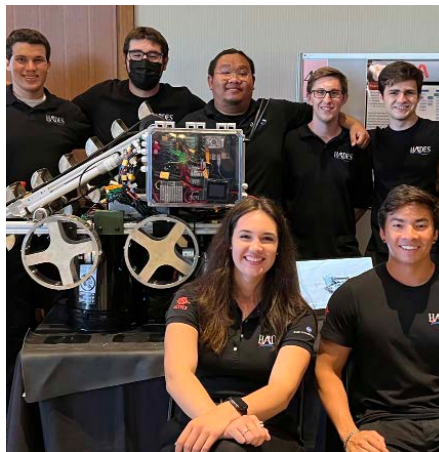



# AEROSPACE ENGINEERING >>>

## AE499: Research Study - PumpWorks

MEMBERS: Angel De La Cruz, Sean Oneil, Daniel Villamil

ADVISOR: Dr. Joseph Katz - SDSU



### Electric Centrifugal Pump

Aerospace Senior Design Project. Designed, built, and tested an electric centrifugal pump for rocket engine applications. This pump utilizes an electric motor as opposed to turbine-driven pumps used in industry. Electric pumps are more efficient and less complex than turbopumps. We would be showcasing the design, actual hardware, and results from testing.

## Astraios Technologies

Sponsored by SDSU Space Lab - AE

MEMBERS: Cruz Betancourt, Bhavana, Kaylin Borders, Angel De La Cruz, Carlos Guerrero, Logan Kuyper, Jaden Lawlor, Sean O'Neil, Ilan Perfecto, Fernando Suarez, Jessie Thompson, Daniel Villamil

ADVISOR: Dr. Ahmad Bani Younes - SDSU

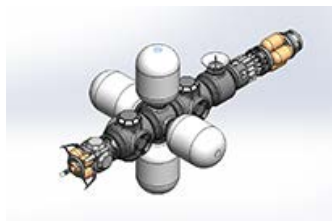

### Project Elysium

A human space vehicle designed to take astronauts from Low Earth Orbit to the dwarf planet Ceres and return them back to Earth.

Poster: [aerospace.sdsu.edu/designday/posters/projectelysium.pdf](https://aerospace.sdsu.edu/designday/posters/projectelysium.pdf)

## Atreides Astronautics

Sponsored by SDSU Space Lab - AE

MEMBERS: Robbie Alazraqui, Charles Duddy, Evan Green, Tyler Hedglin, Samantha Keenan, Chad Kennett, Thomas Langston, Justin Lynch, Liam Mays, Carson Rendell, Jason Ruiz, Emma Topolcsik

ADVISOR: Dr. Ahmad Bani Younes - SDSU



### Removal of Debris in Earth Orbit (RODEO)

As the number of manmade objects in near Earth orbit increases, there is a growing concern for collision resulting in catastrophic loss or the creation of runaway debris fields known as Kessler syndrome. To ensure the safety and feasibility of future space endeavors both manned and unmanned, preventative measures must be taken to avoid such catastrophe. This proposed space debris cleanup mission aims to illustrate a reliable and cost effective mission profile to remove a Russian SL-16 from orbit.

Poster: [aerospace.sdsu.edu/designday/posters/ramdagposter.pdf](https://aerospace.sdsu.edu/designday/posters/ramdagposter.pdf)



**Pew! Aerospace**

Sponsored by SDSU Space Lab - AE

MEMBERS: Olivia Cameron, Christopher Davami, Olivia Decaro, Luke Fernandes, Ian Happel, Catherine Le, Grant Manecke, Cesar Martinez, Casey Pascucci, Nelson Poole, Maverick Villon, Tanner Whitfield

ADVISOR: Dr. Ahmad Bani Younes - SDSU

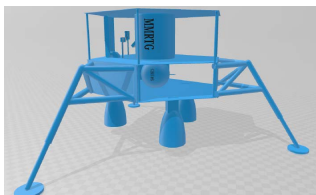

**16-Psyche Probe Autonomous Lander and Drill**

The general mission is to send a data collection and analyzation probe to the asteroid Psyche in order to better understand the origins of the universe. We decided to specialize in the autonomous landing portion of this mission, as well as the flexible arm drill bit that will be utilized.

Poster: [aerospace.sdsu.edu/designday/posters/nomadposter.pdf](https://aerospace.sdsu.edu/designday/posters/nomadposter.pdf)

YouTube Video: <https://www.youtube.com/watch?v=YcikOaq8KZo>

**Project Mothership**

MEMBERS: Justin Caguioa, Jacob Cervantes, Maximilian Dommers, Tanner Harvey, Dylan Lake, Jonathan Ochoa, Christian Okpysh, Jason Peng, Zane Powell, Ryan Twitchell, Dominic Ulloa

ADVISOR: Dr. Joseph Katz - SDSU

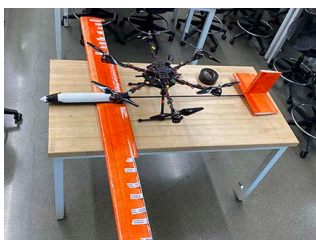

**Spirit of Katz**

Two teams will be part of this project. One team will be in charge of a drone that will take a glider to an altitude of 2km and be able to release it at that height. Another team will be in charge of designing said glider with the capability to be remote control piloted when needed. Additionally, this glider must have a 10:1 glide ratio, meaning it must fly a distance ten times the altitude it was lifted too.

**RamDrag Aerospace**

Sponsored by SDSU Space Lab - AE

MEMBERS: Andres Beltran, Justin Caguioa, Brian Castillo, April Cierley, Devin Ferreira, Joshua McDill, Rezeile Mostrales, Jonathan Ochoa, Omar Ortuno, Zane Powell, Zackary Skinner, Dominic Ulloa

ADVISOR: Dr. Ahmad Bani Younes - SDSU



**Solar Gravitational Lens Telescope**

A spacecraft mission concept of a 2 m aperture telescope capable of taking advantage of the solar gravitational lensing effect to take high-resolution images of exoplanets outside the solar system. The scientific value of our mission is to provide interstellar readings and higher-fidelity images in order to investigate possible life-bearing exoplanets located 25-30 pc away within a generation.

Poster: [aerospace.sdsu.edu/designday/posters/ramdagposter.pdf](https://aerospace.sdsu.edu/designday/posters/ramdagposter.pdf)



# CIVIL, CONSTRUCTION & ENVIRONMENTAL ENGINEERING >>>

## AFJ Engineering (Team 08)

Sponsored by Dokken Engineering

MEMBERS: Ashley Michelle Bides, Alex Salima, Jacquelin Loje Sanchez, Frances Santos, Jacob Skivers

ADVISORS: Professor Sam Amen - SDSU, Professor Tammy Parsons - SDSU, Professor Lima Saft - SDSU, Dr. Julio Valdes - SDSU, Mary Elizabeth Westrum - Dokken Engr., Professor Thomas Zink - SDSU



### Carroll Canyon Road Extension

AFJ Engineering has designed segment T-5A of the Carroll Canyon Road Extension. We have worked hard to design an efficient roadway that connects the community from point A to B, while minimizing the impact on the habitat that surrounds it and we are proud of our work.

**YouTube Video:** <https://www.youtube.com/watch?v=3OoluYaLuUg>

## Arrow Engineering Co. (Team 11)

MEMBERS: Johanna Maeve Ortiz, Malaleh Tajik, Michelle Tran, Ngoc Trang

ADVISOR: Professor Jim Haughey - SDSU



### UCSD Pepper Canyon East Housing

Arrow Engineering Co. (AE) had the opportunity to design and construct a new UCSD Pepper Canyon East Housing Development to provide 3,500 beds in response to a high demand for affordable on-campus housing. The proposed project design will include two high-rise (22- and 23-story) towers with connected mid-rise buildings. The project will include underground parking, a courtyard, a dining facility, a rim trail and an extension of Rupertus Walk.

**YouTube Video:** <https://www.youtube.com/watch?v=Oa0qDacaKUK>

## Aztec Prophets Engineering (Team 12)

MEMBERS: Giuseppe D'Amato, Jacob Inclan, Jordan Kaplan, Saamon Mohammadion, Arnaldo Mora

ADVISORS: Dr. Thais Alves - SDSU, Dr. M. Ziad Bayasi - SDSU, Dr. Hassan Davani - SDSU, Professor Jim Haughey - SDSU, Professor Nensi Lakrori - SDSU, Professor John Prince - SDSU, Dr. Julio Valdes - SDSU



### UCSD Pepper Canyon East Housing Development

UCSD is looking for innovative and qualified company to design and build a new Pepper Canyon East Housing. The apartment complex is in need of a more urban area that can provide mix-use and solidarity. This particular project includes most civil engineering practices due to the scope of project. The general scope of work includes storm water analysis, site development design, geotechnical study, and structural analysis. Challenges faced include existing slopes, retaining walls and to maintain access to PCWH construction.

**YouTube Video:** [https://www.youtube.com/watch?v=uhxryWr9\\_9A](https://www.youtube.com/watch?v=uhxryWr9_9A)

### Bauen International (Team 17)

MEMBERS: Tareq Alsharif, Anthony Kyle Sta Ines, Drew Moore, Diego Herrera Valera

ADVISOR: Professor Jim Haughey- SDSU



#### UCSD Hillcrest Hospital Development

Bauen International is designing and constructing a new 300-bed Hospital Tower, Arrival Court, Multi-purpose Building, Central Utility Plant, and Courtyard for UCSD, who is looking to redevelop their Medical Center campus in Hillcrest with the purpose of bringing the most advanced science and research to their community in order for people to lead better, healthier lives.

**YouTube Video:** [https://www.youtube.com/watch?v=k5k7YrY\\_Bbk](https://www.youtube.com/watch?v=k5k7YrY_Bbk)

### CGJJ Engineering Solutions Inc. (Team 18)

MEMBERS: Cesar Cabrera, Josh Joksch, Giorgi Kontselidze, Justin Nelson

ADVISORS: Professor Jim Haughey - SDSU, Dr. Julio Valdes - SDSU, Professor Dan Werdowatz - SDSU, Professor Thomas Zink - SDSU



#### UCSD Hillcrest Hospital Development

The primary objective for this project is to improve UC San Diego Health’s medical network by producing plans for phase 4 of the replacement of Hillcrest Hospital located on the northern bluff of Hillcrest in San Diego. The plans include design schemes which span the primary disciplines of Civil Engineering. From Site civil and demolition to stormwater analysis, geotechnical engineering, structural analysis, potable water and wastewater, and transportation engineering.

**YouTube Video:** <https://www.youtube.com/watch?v=1XJ7NQnbdT0>

### Charisma Consultants (Team 21)

Sponsored by Richard Brady & Associates, Inc.

MEMBERS: Zain Batta, Jacob Callahan, Jered Relopez, Jonathan Weisberg

ADVISORS: Rick Brady - Richard Brady & Associates, Inc., Professor Mark Filanc - SDSU

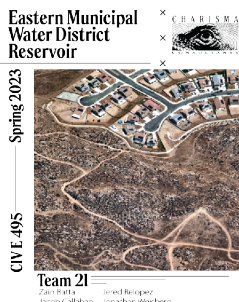

#### Eastern Municipal Water District Reservoir Tank

Our project is to site a new water storage reservoir to service communities in San Bernardino, taking into account the hydraulic and geotechnical constraints. Access road plans along with grading and drainage reports will also be provided. Lastly, a bid budget and construction schedule will be included.

**YouTube Video:** <https://www.youtube.com/watch?v=gWFpZtUeavl>

## Costa Ulan Engineers (Team 20)

MEMBERS: Zahraa Almamoori, Amira Andrews, Jacey Domingsil, Sophia Jorge, Lillian Le

ADVISORS: Professor Sam Amen - SDSU, Professor Tammy Parsons - SDSU, Dr. Lima Saft - SDSU, Dr. Julio Valdes - SDSU, Mary Elizabeth Westrum, Professor Thomas Zink - SDSU



### Encinitas Community Park Stormwater Reuse

To successfully complete this project of designing a stormwater capture, storage, treatment, and distribution system for irrigating stormwater at the community park in Encinitas, California, Costa Ulan Engineers will devise an initial project plan and conduct an initial site assessment.

**YouTube Video:** <https://www.youtube.com/watch?v=ZJ2UtofuiVo>

## Cove Consulting (Team 03)

Sponsored by SANDAG & QIC

MEMBERS: Jonathan Martinez Magana, Elizabeth Mehlhorn, Jonnathan Santos Mendez, Emma Raymer, Eric Weldon, William Yeager

ADVISOR: Professor Nensi Lakrori - SDSU



### Vista Inland Rail Trail

The main task of this project is to design and construct a Class 1 bike path starting from Mar Vista Drive and ending at Civic Center Drive. This project spans approximately 1-mile in length and is a singular part of a 21-mile bike path plan. Our main challenges will be creating retaining walls, navigating property boundaries, grading the soil, managing the gas line that runs along the path, and ensuring proper drainage.

**YouTube Video:** <https://www.youtube.com/watch?v=GL3g0xruUJ8>

## DIME Engineering (Team 05)

MEMBERS: Mario Garcia Carbajal, Matthew Corradetti, Irving Figueroa Hernandez, Daniel Matsumoto, Emmett Wackford

ADVISORS: Vitaliy Danchuk - T.Y. Lin, Professor Jeremy Lahaye - SDSU, Austin Young - Caltrans



### San Diego River Bridges

The purpose of this project is to design an overcrossing in the form of a pedestrian bridge at four locations, and ultimately choose the most feasible one. The scope of our project is to provide a safe and efficient design that minimizes construction time, and follows all design constraints. In order to achieve this, we have chosen to go with precast concrete. Although some intersections prove to be difficult due to surrounding structures and utilities, having alternatives allows us to compare and improve our design.

**YouTube Video:** <https://www.youtube.com/watch?v=Pxhq10-hifM>

**eTron Engineering (Team 09)**

Sponsored by Dokken Engineering

MEMBERS: Maryam Al Aboosi, Ka Hung Nicholas Chuk, Sinan Daraji, Bassam Musfee

ADVISORS: Professor Jeremy LaHaye - SDSU, Professor John Prince - SDSU, Dr. Julio Valdes - SDSU

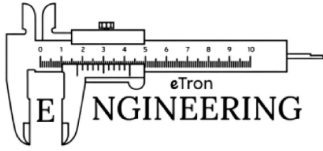

**Carroll Canyon Road Extension**

The Carroll Canyon Road Extension engineering design project is to provide a new east/west corridor between the I-805 and I-15 freeways. The project will involve comprehensive planning, design, and construction of a new roadway that includes necessary interchanges, and other related infrastructure. This project will require coordination among various stakeholders, including local and government agencies, as well as private entities. The approach to this project will prioritize the development of a comprehensive engineering design plan that considers the needs of the local community and the potential environmental, economic, and safety impacts of the proposed roadway. The final deliverable of this project will be a safe and efficient roadway that will benefit the local community and support regional transportation needs.

**YouTube Video:** [https://www.youtube.com/watch?v=OCOJ\\_hB1J5I](https://www.youtube.com/watch?v=OCOJ_hB1J5I)

**GREENCO Engineering (Team 04)**

MEMBERS: Natasha Botros, Humberto González, Abdallah Hammad, Ihsan Hassan, Yousif Kiryakous, Mariam Yousif

ADVISORS: Professor Nensi Lakrori - SDSU, Dr. Julio Valdes - SDSU, Professor Dan Werdowatz - SDSU, Dr. Ehsan Goodarzi - SDSU



**Vista Inland Rail Trail**

Our Project is on the Inland Rail Trail, a Class I Bike Lane that runs alongside the Sprinter light rail service. Our scope will focus on the continuation of the Inland Rail Trail through the city of vista. Our team of engineers is asked to design phase 3 of the Vista Inland Rail Trail that runs from the intersections of Mar Vista Dr. to Civic Center Dr. The challenges of the site are the major need for retaining walls, creating drainage facilities, and aligning a safe bike path for all users.

**YouTube Video:** [https://www.youtube.com/watch?v=Y\\_ZZqlH6ZeU](https://www.youtube.com/watch?v=Y_ZZqlH6ZeU)

**JTI Builders (Team 22)**

Sponsored by Richard Brady & Associates, Inc.

MEMBERS: Luke Bisbal, Jarret Isaacson, Michael Moran, Diego Munoz-Izaguirre, Anthony Parker

ADVISORS: Rick Brady - Richard Brady & Associates, Inc., Professor Mark Filanc - SDSU



**Eastern Municipal Water District Reservoir Siting & Civil**

Grading of site access road and site locations for future installation of water reservoir. Design of retaining walls for the site and new utilities to connect from the reservoir to public utilities.

**YouTube Video:** <https://www.youtube.com/watch?v=iHNVXnYy6Nc>



**KABS Engr. & Solid Waste Management (Team 26)** Sponsored by Encina Wastewater Authority

MEMBERS: Ciara Atencio, Hussain Burammanah, Cole Kinkade, Stephanie Songer

ADVISORS: Donald Cutler - Encina Wastewater Authority, Jimmy Kearns - Encina Wastewater Authority, Ramin Yazdi - SDSU



**Encina Digester 4 Rehabilitation**

The digester needs to be repaired and innovated whilst meeting the standards for safety, being low-impact on the environment/facility, and more efficiently treating the sludge that passes through it. This will be achieved by the implementation of new cost-effective design elements such as pumps, heat exchangers, and materials used. Finally, contractors will be used to handle the cleaning of the digester and repairs to the post-tensioned tank.

**YouTube Video:** [https://www.youtube.com/watch?v=SCT32wW9\\_WU](https://www.youtube.com/watch?v=SCT32wW9_WU)

**Kodac Design (Team 10)**

MEMBERS: Jacquelin Silva Campos, Anica Deche, Devona Kassab, Raanya Kushkaki

ADVISOR: Professor Jim Haughey - SDSU



**UCSD Pepper Canyon East Housing Development**

Design and construct a more urban, dense, mixed-use neighborhood to meet future housing and academic goals. Replace the existing Pepper Canyon East Apartments as well as existing parking and the current Foodworx, Pepper Canyon, Mathers, Rita Atkinson, and the Warren Tennis courts. Other project components will include three-thousand five hundred bedrooms, covered parking, a dining hall, a courtyard, a rim trail, and access to the UCSD Central Campus Trolley Station.

**YouTube Video:** <https://www.youtube.com/watch?v=oFuB3GxEqVs>

**Lancaster Co. (Team 25)**

Sponsored by Encina Wastewater Authority

MEMBERS: Daniel Brito, Sydney Burnham, Amanda Dahl, Mia Lancaster, Jimmy Nguyen

ADVISORS: Donald Cutler - Encina Wastewater Authority, Professor Mark Filanc - SDSU, Jimmy Kearns - Encina Wastewater Authority



**Encina Digester 4 Rehabilitation**

This project will focus on the rehabilitation of Digester 4 which is a tank that treats wastewater to collect and use the renewable resource called biogas. The Digester was constructed back in 1980 and Encina JPA wishes to rehabilitate the infrastructure. The project requests that the Digester's interior concrete walls be repaired before being equipped with a modern and more efficient heating and mixing system to promote a less environmentally impacting operation.

**YouTube Video:** <https://www.youtube.com/watch?v=wqpwAbfcV44>

**MAGUS CONSULTANTS, INC. (Team 06)**

MEMBERS: Gabe Adkins, Uri Bobrycki, Scott Raspolich, Alex Ulricksen, Matt Wall

ADVISORS: Dr. Hassan Davani - SDSU, Dr. Robert Dowell - SDSU, Professor Jeremy Lahaye - SDSU, Professor Nensi Lakrori - SDSU, Dr. Julio Valdes - SDSU, Professor Dan Werdowatz - SDSU, Professor Emir Williams - SDSU, Naomi Willis - Kimley-Horn



**San Diego River Bridges**

Magus Consultants will design a grade separated crossing for the San Diego River Bikeway at Camino Del Este to provide a safe, uninterrupted, segue for those commuting on the bike path. Additionally, the improvement will allow more efficient commute times for vehicles traveling through Mission Valley, enhanced safety for bicyclists crossing Camino Del Este, and improved beautification for Mission Valley.

**YouTube Video:** <https://www.youtube.com/watch?v=o9rpOSvh5Ws>

**MASA Civil & Construction Development Inc. (Team 23)**

Sponsored by Richard Brady & Associates, Inc.

MEMBERS: Mustafa Abduilwahid, Tyler Abell, Blake Morton, Brian Seaman

ADVISORS: Professor Mark Filanc - SDSU, Rick Brady - Richard Brady & Associates, Inc.



**Eastern Municipal Reservoir Development**

The Eastern Municipal Reservoir Development project is aimed at improving access to and improving the redundancy of the water system for the Eastern Municipal Water District. The project includes the design of the reservoir site as well as an access road and connections to utilities. The project will include work such as site civil, transportation, hydraulics, and hydrology.

**YouTube Video:** <https://www.youtube.com/watch?v=33r0btoCGvE>

**MIP Construction (Team 01)**

MEMBERS: Christina Margosian, Kaitlin Ibbotson Martin, Vikesh Parmar, Bryant Pitts

ADVISORS: Mary Elizabeth Westrum - Dokken Engr., Professor Emir Williams - SDSU

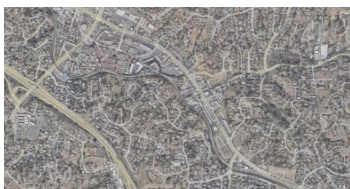

**Vista Inland Rail Trail**

The Vista Inland Rail Trail project is one that revolves around constructing a Class I, ADA compliant bike path. The project spans across multiple counties and cities; Oceanside, Vista, San Diego and San Marcos are all in on this 23 mile long project. With Phase 1 & 2 of the projected complete, Phase 3, a 1-mile long segment between Civic Center Drive and Mar Vista Drive in Vista, CA, is the task that been assigned to our group at MIP.

**YouTube Video:** [https://www.youtube.com/watch?v=\\_8oHmvQ5sQ4](https://www.youtube.com/watch?v=_8oHmvQ5sQ4)

## Phyto-Sea Sustainable Engineering (Team 27)

MEMBERS: Skye Benson, Nolan Ciccone, Morgan Edmunson, Emma Isaacson, Roan Weston

ADVISORS: Ryan Davis, Dr. Christy M. Dykstra - SDSU, Professor Mark Filanc - SDSU, Dan Pentico, Ramin Yazdi - SDSU



### Salton Sea Phytoremediation System Design

Phyto-Sea plans on designing a phytoremediation system to help purify heavily polluted water from the Alamo River, a Salton Sea tributary. The design entails diverting the water from the tributary into our proposed system where it can be biologically treated by native macrophytes. A process study along with a watershed investigation and hydraulic calculations are paramount when considering our designing criteria.

**YouTube Video:** <https://www.youtube.com/watch?v=JwEAqZ6uRsk>

## PILK Engineering (Team 16)

MEMBERS: Inayah Morris, Kelly O'Flaherty, May Sphabmixay, Penelope Zavala

ADVISOR: Professor Jim Haughey - SDSU



### County Highland Valley Road Drainage Improvements

Designing drainage solutions for a road section that experiences heavy flooding during peak wet weather conditions.

**YouTube Video:** [https://www.youtube.com/watch?v=6TDCiiOB\\_WY](https://www.youtube.com/watch?v=6TDCiiOB_WY)

## R.D.S. Co. (Team 07)

Sponsored by Dokken Engineering

MEMBERS: Ameer Aljuboori, Daniel Aziz, Mohammed Nabee, Nawres Qarandal, Dena Toshee

ADVISORS: Professor Sam Amen - SDSU, Shawn Krause, Mary Elizabeth Westrum - Dokken Engr.

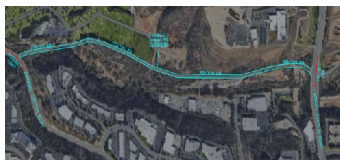

### Carroll Canyon Road Extension

A road extension project between Carroll Canyon Road and Camino Santa Fe which consists of redeveloping and extending the existing road (Fenton Rd) to Camino Santa Fe.

**YouTube Video:** <https://www.youtube.com/watch?v=58HVqd1PLWY>

**SAFE Engineering (Team 13)**

MEMBERS: Abril Alcaraz, Esau Ambriz, Francisco Lopez Avila, Sebastian Galsim

ADVISOR:

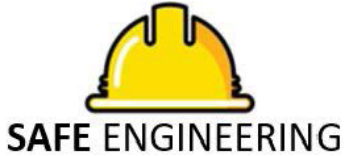

**UCSD Pepper Canyon East Housing Development**

The University of California San Diego (UCSD) is seeking Design-Build Entities qualified to design and construct a new UCSD Pepper Canyon East Housing Development. The project shall replace the existing Pepper Canyon East Apartments. The goal is to create a better sense of community and better meet the University’s strategic vision.

**Schiit Works Engineering (Team 02)**

Sponsored by SANDAG

MEMBERS: Christian Aquinde, Amin Ghahremani, Hilton Nguyen, Daniel Vega

ADVISOR: Professor Jeremy Lahaye - SDSU

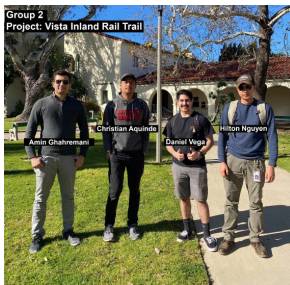

**Vista Inland Rail Trail**

This is a design project for a Class I bike path that runs parallel to the sprinter track in the city of Vista. The project will practice sustainability and follow ADA regulations. It will be located on the South side of the tracks and will connect the existing bike path on Mar Vista Dr. to the Sprinter station. The project will require grading of the site and retaining wall expansions to make room for the bike path.

**YouTube Video:** <https://www.youtube.com/watch?v=dOgGyCwSL8g>

**SDB Engineering (Team 14)**

Sponsored by Snipes-Dye Associates & West Coast Civil

MEMBERS: Dustin Bui, Taylor Green, Grace McKenzie, Kent Monkarsh, Ahmad Najem, Luke Ramos

ADVISORS: Alberto Fernandez - ISEC Inc., Sean McCarty - West Coast Civil, Kyle McCarty - West Coast Civil, Son Nguyen, Professor Thomas Zink - SDSU

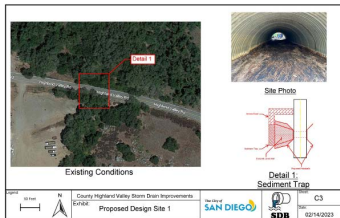

**County Highland Valley Road Drainage Improvements**

Highland Valley Road is a recently repaved 2.6 mile long road located east of Interstate 15 in San Diego, California. Due to recurring flooding and faulty storm drainage, storm drain reconstruction efforts including a thorough storm drain analysis and a replacement of current storm drain culverts. Our comprehensive storm drain reconstruction project will include a proficient storm water design, improvements to the City of San Diego public road system, and a means of reliable transportation for local residents.

**YouTube Video:** <https://youtu.be/u509kftA-zs>

## Seaside Engineering (Team 15)

MEMBERS: Yaqub Abdo, Leslie Arenas, Karol Atesha, Ricardo Quinta

ADVISOR: Professor Jim Haughey - SDSU



### County Highland Valley Road Drainage Improvements

The project includes public road improvements to remove reoccurring flooding and storm drain capacity issues along approximately 2.6 miles of road. The scope of work includes storm drain analysis and/or replacement of existing roadway storm drain culverts in at least four locations.

**YouTube Video:** <https://www.youtube.com/watch?v=cD8PGYa0GWs>

## Springs Associates (Team 24)

Sponsored by Richard Brady and Associates, Inc.

MEMBERS: Alexondra Acosta, Bethany Anderson, Jaclyn Brown, Juliet Luevanos

ADVISORS: Rick Brady - Richard Brady & Associates, Inc., Dr. Thais Alves - SDSU, Professor Nensi Lakrori - SDSU, Garrett Murawsky - Richard Brady and Associates, Inc.



### Eastern Municipal Water District Reservoir siting and Civil

The purpose of this project is to develop a Reservoir to store and supply water to the Winchester community. The Reservoir will include a pump system that is responsible for transporting the water from Diamond Valley Lake. In order to access the reservoir, an access road will be built along with a road surrounding the perimeter of the site. Our team will be providing various deliverables such as a Site Development Plan, Construction Estimate, Geotechnical Report, Storm Drain Study and many others.

**YouTube Video:** <https://www.youtube.com/watch?v=QVec-quqy9Y>

## VACKZ Engineering (Team 19)

MEMBERS: Adam Gil, Kameron Lumanlan, Victoria Powell, Zachary Register, Craig Sutter

ADVISOR: Rami Selim - BKF Engineers



### Encinitas Community Park Stormwater Capture and Reuse

In this project, we aim to design and construct a water treatment and storage tank that is functional, sustainable, and cost-effective. This water will be stored and dispersed throughout the park for irrigation purposes to reduce the city's water consumption. Currently, the city irrigates the Encinitas Community Park using domestic and recycled water. Identifying rainwater resources on and off site and determining how much can be stored for use in dry weather is a central elements of the project.

**YouTube Video:** [https://www.youtube.com/watch?v=Bbxxd-u\\_98w](https://www.youtube.com/watch?v=Bbxxd-u_98w)

# ELECTRICAL & COMPUTER ENGINEERING >>>

## Navi

Sponsored by Dr. Andrew Szeto, Professor Emeritus, SDSU

MEMBERS: Mike Cao, Sean Clark, Cesar Gonzalez, Yen Pham, Jason Wu

ADVISOR: Dr. Hakan Töreysin - SDSU

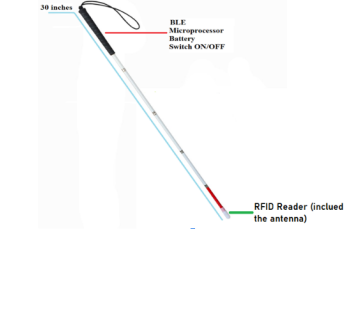

### Navicane

Navicane is an RFID assisted smart cane that will harness passive tags to help navigate the visually impaired indoors. The device will feature an RFID reader assembly that will identify the data coded on door tags, convert it to digital data which will be passed to an embedded microcontroller. The microcontroller will identify the data and pass accurate information over Bluetooth to a smartphone application. This technology will allow for easier and quicker identification of key entrances and exits.

Poster: [electrical.sdsu.edu/designday2023/posters/team10-navicane.pdf](http://electrical.sdsu.edu/designday2023/posters/team10-navicane.pdf)

YouTube Video: [https://www.youtube.com/watch?v=TLdZcfJYJ\\_c](https://www.youtube.com/watch?v=TLdZcfJYJ_c)

## OxySquad

Sponsored by Dr. Andrew Szeto, Professor Emeritus, SDSU

MEMBERS: Sarmad Dawood, Sean Doan, Janvincent Gawaran, Michael Martineau, Gabriel Miller

ADVISOR: Dr. Hakan Töreysin - SDSU

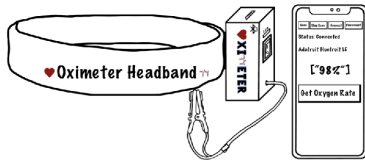

### Pulse Oximeter

The pulse oximeter is a portable Bluetooth enabled device that uses light measurements to calculate the blood oxygen levels in a person's body. This device had been engineered as an earpiece that measures from the ear as opposed to taking measurements from a finger. Our design is battery operated and rechargeable for continued long term use.

Poster: [electrical.sdsu.edu/designday2023/posters/team16-oxygenlevelsensor.pdf](http://electrical.sdsu.edu/designday2023/posters/team16-oxygenlevelsensor.pdf)

YouTube Video: <https://youtu.be/7FSsC6g3Nn4>

## Signal Sleuths

Sponsored by SDSU Electrical & Computer Engineering Department

MEMBERS: Louise Van Aken, Ezra Gonzalez, Trent Moca, Cade Ramirez, Jarrod Rowson

ADVISOR: Dr. Ashkan Ashrafi - SDSU

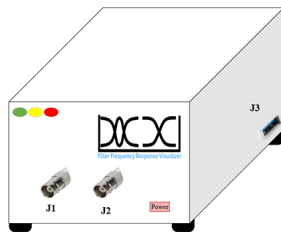

### Filter Frequency Response Visualizer

The Filter Frequency Response Visualizer or FFRV is a Bode plot visualizer utilizing analog circuit design to obtain magnitude and phase response of a passive electrical filter. A user of the product will use their computer and a computer interface designed by the team to visualize and then download the frequency response of the circuit as a Comma Separated Value (CSV) file.

Poster: [electrical.sdsu.edu/designday2023/posters/team18-signalsleuths.pdf](http://electrical.sdsu.edu/designday2023/posters/team18-signalsleuths.pdf)

YouTube Video: <https://youtu.be/mzOH8Nq5-oA>

## The Synthesizers

Sponsored by SDSU Electrical & Computer Engineering Department

MEMBERS: Abdullah Altawheed, Michael Fallon, Andres Medina Gonzalez, Tiber Hernandez, Tharaa Rahhal, Elisha Reece

ADVISOR: Professor Barry Dorr - SDSU



### Frequency Modulation Music Synthesizer in FPGA

The FPGA FM Synthesizer is a replacement for software-aided synthesis. Plugging in a MIDI keyboard, it processes the digital input bitstream and uses fixed-point DSP to output an analog sound wave. It can produce up to 16 voices, note bending, and can generate sine, square, sawtooth and triangle waves. Frequency modulation is done by selecting the amplitude and frequency of a modulating signal. This system uses a System-On-Chip, combining the flexibility of a processor and hardware acceleration of programmable logic.

Poster: [electrical.sdsu.edu/designday2023/posters/team9-fmmusicsynthesizer.pdf](https://electrical.sdsu.edu/designday2023/posters/team9-fmmusicsynthesizer.pdf)

Youtube Video: [https://youtu.be/\\_i-5K3oeY6c](https://youtu.be/_i-5K3oeY6c)

## The VU-inator

Sponsored by SDSU Electrical & Computer Engineering Department

MEMBERS: David Balderrama Solorio, Richard Chial, Danny Colmenarez, Ali Noory, Gabriel Sawaya

ADVISORS: Professor Barry Dorr - SDSU, Professor Christopher Warren - SDSU



### Audio VU Meter

The VU (volume unit) meter is designed for users who wish to see a visual representation of audio volume and to aid in refining audio recordings. It will be able to connect to any device that can produce audio via a 1/4" jack and displays peaks of that audio across a frequency spectrum limited to the range of human hearing via LED columns.

Poster: [electrical.sdsu.edu/designday2023/posters/team4-audiovumeter.pdf](https://electrical.sdsu.edu/designday2023/posters/team4-audiovumeter.pdf)

YouTube Video: <https://youtu.be/LcRzPxK-Kjo>

## TuneTech

Sponsored by SDSU Electrical & Computer Engineering Department

MEMBERS: Somer Hanna, Matthew Hughes, Ara Jacob, AJ Rodrigo, Eric Taft

ADVISOR: Professor Barry Dorr - SDSU

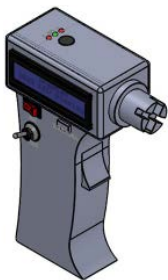

### Automatic Guitar Tuner

The Automatic Guitar Tuner is a smart, motorized device that will aid musicians in tuning their guitars accurately and efficiently. This handheld device features a display allowing the user to select the correct string and showcase the frequency being picked up. Smaller LEDs are also included to monitor the tuning status at a glance. The device is connected to a guitar via a standard 1/4" Aux connection. The device is held over a tuning knob, the user strums a guitar string, then the motor automatically tunes it.

Poster: [electrical.sdsu.edu/designday2023/posters/team1-automaticguitartuner.pdf](https://electrical.sdsu.edu/designday2023/posters/team1-automaticguitartuner.pdf)

YouTube Video: [https://youtu.be/\\_HbLfaopAb8](https://youtu.be/_HbLfaopAb8)

# ELECTRICAL & COMPUTER AND MECHANICAL ENGINEERING >>>

## A.R.M.P.I.T.

Sponsored by Booz Allen Hamilton & SDSU Troops to Engineers

MEMBERS: Barry Baker, Milan Bujosevic, Andrew da Cunha, Brian Herman, Trent McGill, Nathan Reynolds, Sammy Samaniego, Ackara Seav, Oliver Shirley, Nathan Whitford

ADVISORS: Professor Barry Dorr - SDSU, Dr. Scott Shaffar - SDSU

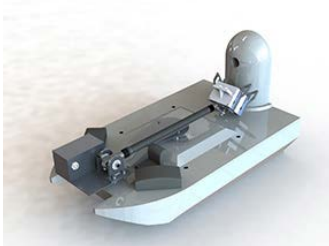

### RES3RA

RES3RA is a deck-mounted attachment for Booz Allen Hamilton's MANTAS (Man-Portable Tactical Autonomous System). The modular attachment will enhance the unmanned surface vessel's ability to perform reconnaissance and surveillance missions. Currently, the delivery of surveillance payloads is performed by two operatives that jet ski to the target vessel and attach the payload to its hull with a long pole. The RES3RA aims to accomplish the same task in tandem with MANTAS, thus removing operatives from potential danger.

Poster: [electrical.sdsu.edu/designday2023/posters/project02-res3ra.pdf](https://electrical.sdsu.edu/designday2023/posters/project02-res3ra.pdf)

YouTube Video: <https://www.youtube.com/watch?v=nUOWkVtFQoE>

## ARGUS III

Sponsored by US Department of Defense & National Security Innovation Network

MEMBERS: Jaime Isaiah Cervantes, Anthony Duyan, Blake Elliott, Noah Hinckley, Sonya Lored, Andrew Mapes, Diana Mudeer, Philip Phan, Joseph Solis, Carson Vogel

ADVISORS: Professor Barry Dorr - SDSU, Kevin Demesa - US Navy, Chris Curran - US Navy, Dr. Scott Shaffar - SDSU



### ARGUS III Remote Wildfire Sensing

The ARGUS III Remote Wildfire Sensing Program consists of a 10 person team tasked to design and create a functioning device that will assist the US Navy with tracking wildfires for firefighting purposes. The module uses electronics that help track important characteristics of fires such as humidity, temperature, and location. The device is made from 3D printed high impact and heat resistant material, and will be dropped via drone into fire active or prone areas. The design features five sub-assemblies with their own integrated electronics.

Poster: [electrical.sdsu.edu/designday2023/posters/project08-argus3.pdf](https://electrical.sdsu.edu/designday2023/posters/project08-argus3.pdf)

YouTube Video: <https://www.youtube.com/watch?v=sskr2QGbs24>

## Autoclox

Sponsored by Masimo

MEMBERS: Oscar Campos, Eddie Donovan, Abdullah Bin Essa, Matthew Fontimayor, Kendra-Rose Jucal, Samuel Kenny, Luka Kurashvili, James McGill, Cody Nephew, Olivia Orren

ADVISORS: Stanley Chang - Masimo, Professor Barry Dorr - SDSU, Glenn Pohly - Masimo, Jake Prittie - Masimo, Dr. Scott Shaffar - SDSU, Jasmine Zhang - Masimo



### Smart Cure Cabinet Monitoring System

The Smart Cure Cabinet Monitoring System is an electrically integrated cabinet system to be used by Masimo's production workers to register component information through a barcode system, assign the component a curing location and time, track its curing progress, and indicate the product's curing status to other production workers. Status will be shown by four timer modules attached to the cabinet, along with six others that can be attached to different curing station setups including open racks, cabinets, and ovens.

Poster: [electrical.sdsu.edu/designday2023/posters/project15-smartcurecab.pdf](https://electrical.sdsu.edu/designday2023/posters/project15-smartcurecab.pdf)

YouTube Video: <https://www.youtube.com/watch?v=g7J0foWMLBc>



**EZ Drive**

Sponsored by Quality of Life Plus

MEMBERS: Larry Arango, Dominic Bartlewski, Justin Cao, Briareus Castillo, Jerrick Claridad, Taiyo Gurule, Tanner Makar, Thomas Marshall, Tyler-Benjamin Puspos, Shakiba Abdul Sattar

ADVISORS: Professor Barry Dorr - SDSU, Scott Huyvaert -Quality of Life Plus, Dr. Scott Shaffar - SDSU

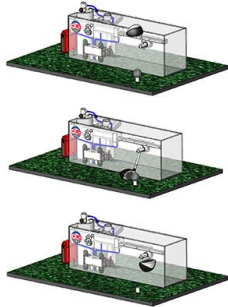

**Golf Club System for Wheelchair Players**

Our innovative device is specifically designed to enable disabled golfers to enjoy the game of golf, even if they cannot swing a golf club. Our goal is to overcome the limitations posed by physical disabilities through a sophisticated mechanical design. With just the press of a button, our device will be able to launch a golf ball down the fairway, using an accessible control mechanism such as a sip-and-puff system. This means that wheelchair-bound users with limited mobility can now participate in this great sport and experience the joy of hitting a golf ball.

Poster: [electrical.sdsu.edu/designday2023/posters/project31-teamezdrive.pdf](https://electrical.sdsu.edu/designday2023/posters/project31-teamezdrive.pdf)

YouTube Video: <https://www.youtube.com/watch?v=28-nG493K0I>

**Granola To Go**

Sponsored by D&K Engineering

MEMBERS: Joshua Alanzalon, Rylan Bumbasi, Jian Cai, Nathan Dockswell, Lauren Halbach, Dylan Mazzarella, Manuel Medina, Jarlen Nicholos, Joseph Placido, Rodrigo Sosa

ADVISORS: Professor Barry Dorr - SDSU, Dusty Fisk - D&K, Wayne Jackson - D&K, John Reep - D&K, Dr. Scott Shaffar - SDSU

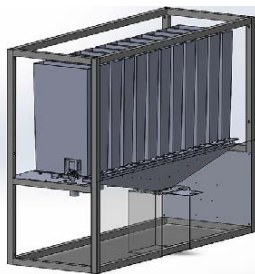

**Smart Granola Kiosk**

D&K Engineering has enlisted the help of SDSU students in designing a Smart Granola Kiosk capable of accepting user input for payment and ingredient selection. Customers will use an app to place orders via a tablet on the kiosk or through a smartphone via a mobile app. Once an order is placed, the granola then dispenses to the customer via a food safe delivery system. The kiosk will be modular and food safe according to FDA regulations.

Poster: [electrical.sdsu.edu/designday2023/posters/project03-smartgranolakiosk.pdf](https://electrical.sdsu.edu/designday2023/posters/project03-smartgranolakiosk.pdf)

YouTube Video: <https://www.youtube.com/watch?v=clm26TmhAJk>

**HAFNA**

Sponsored by Laird

MEMBERS: John Pateros, Conor O'Mahoney, Caleb Nieto, George Yousif, Livar Mikha, Peter Marrone, Cindy Rios, Christopher Rodriguez, Tyler Simmons, Christian Suatengco

ADVISORS: Sarah Cartwright - Laird, Dr. Barry Dorr - SDSU, Dr. Scott Shaffar - SDSU



**Horn Antenna Fixture for Network Analyzer**

The Horn Antenna Fixture for Network Analyzer is a joint Mechanical, Electrical, and Computer Engineering team project working to design, build, test, and document an automated test fixture for a network analyzer used to measure insertion and reflection loss of materials. The test fixture was designed for Laird R&F Products, who develops high-performance materials for the aerospace and defense markets and conducts insertion and reflection loss tests to determine the radio frequency properties of their products.

Poster: [electrical.sdsu.edu/designday2023/posters/project06-teamhafna.pdf](https://electrical.sdsu.edu/designday2023/posters/project06-teamhafna.pdf)

YouTube Video: <https://www.youtube.com/watch?v=CtLHXBOGIE8>

**LUV Engineering**

Sponsored by Masimo

MEMBERS: Tanner Askey, Nathaniel Guba, Sara Herrera, Matthew Hui, Lorance Malan, Davis Owen, Calvin Phan, Lauren Prentiss, Micaela Rafael, James Scobie, Brayon Rosas Vera

ADVISORS: Stanley Chang - Masimo, Braeden Clewis - Masimo, Professor Barry Dorr - SDSU, Austin Pike - Masimo, Glenn Pohly - Masimo, Dr. Scott Shaffar - SDSU, Pratul Singh - Masimo, Jason von Wilpert - Masimo

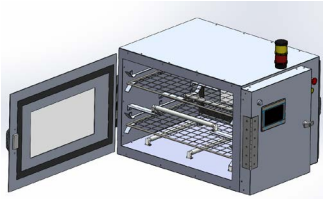
**Automated UV-C Disinfecting Oven**

Team LUV Engineering has collaborated with Masimo engineers to design, document, and fabricate a system that emits UV-C light to all sides of various bagged and packaged medical objects for a known and controlled amount of time. Masimo uses UV-C light to disinfect finished medical products in a factory-line environment. This project aims to improve the UV-C disinfecting process that is currently used at Masimo by maximizing throughput and enhancing operational safety.

**Poster:** [electrical.sdsu.edu/designday2023/posters/project14-autouvcover.pdf](https://electrical.sdsu.edu/designday2023/posters/project14-autouvcover.pdf)

**YouTube Video:** <https://www.youtube.com/watch?v=-e6-Akb7wZ4>

**Mechanical Assembly Display Automation (MADA)**

Sponsored by General Atomics - Aeronautical Systems

MEMBERS: Nathaniel Cordero, Jacob Cutter, Chris D'orazio, Lotanna Ene, Sinan Kamil, Alan Ta, Allen Ugalde, David Villareal

ADVISORS: Professor Barry Dorr - SDSU, Timothy Novinger - General Atomics, Dr. Scott Shaffar - SDSU, Michael Spies - General Atomics, Patrick Veth - General Atomics

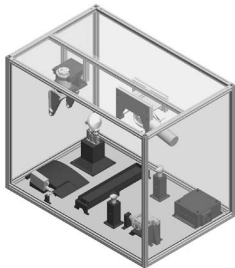
**Mechanical Assembly Display Automation**

General Atomics Aeronautical Systems is one of the world leaders in the design and manufacture of Unmanned Aircraft Systems, radars, and electro-optic products. The goal of the Mechanical Assembly Display Automation is to manufacture a dynamic display, that will contain, and display the functions of components found within General Atomic-ASI's facilities and products. Users will be able to control the components located within the enclosure to view and understand how these parts operate.

**Poster:** [electrical.sdsu.edu/designday2023/posters/project13-mada.pdf](https://electrical.sdsu.edu/designday2023/posters/project13-mada.pdf)

**Motorvators**

Sponsored by Aztec Electric Racing

MEMBERS: Bader Alshammari, Trevor Arellanez, Eugenio Casta, Tyler Chu, Evan Cuyler, Joseph Fraticelli, Pamela Gallardo, Jonas Schulson, Jack Topoleski, Cyrus Yousefian

ADVISORS: Professor Barry Dorr - SDSU, Dr. Scott Shaffar - SDSU

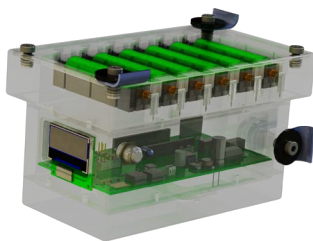
**Grounded Low Voltage Power Supply for an Electric Formula SAE Race Car**

We have developed a compact, fire/water-proof Grounded Low Voltage Battery Power Supply for the SDSU Aztec Electric Racing Team to mount to their competition vehicle. It has a dual output power supply, powered by rechargeable batteries, with a battery management system to protect the electronics; an LCD screen to output live readouts of battery temperature, voltage, and current; and a pushbutton to light up an LED and initiate recording and storing of this data to be analyzed later.

**Poster:** [electrical.sdsu.edu/designday2023/posters/project29-groundlowvoltagebattery.pdf](https://electrical.sdsu.edu/designday2023/posters/project29-groundlowvoltagebattery.pdf)

**YouTube Video:** <https://www.youtube.com/watch?v=d4o2hTOYvgM>

## S.C.A.N. Robotics

Sponsored by SDSU Mechanical Engineering Department

MEMBERS: David Aw, Christopher Choo, Abelardo Garcia, Cameron Jaynes, Sophie Koehler, Shingo Morita, Shahad Al Neesan, Andrew Richter, Martin Ruiz, Uriel Zamorano

ADVISORS: Dr. Zahra Nili Ahmadabadi - SDSU, Professor Barry Dorr - SDSU, Dr. Scott Shaffar - SDSU

**Coordinated Multi-Robots for Planetary Exploration**

The team is developing a new lightweight space robot that is multi-coordinated robotic system. The robot has the capabilities to be able to access and explore more challenging Martian sites such as Hellas Planitia. The robot has the ability to exceed the force and payload capabilities to carry five times its own mass. It also has the inventive technology of soft robotics allowing for the retrieval of a myriad of samples.

**Poster:** [electrical.sdsu.edu/designday2023/posters/project35-teamsan.pdf](https://electrical.sdsu.edu/designday2023/posters/project35-teamsan.pdf)

**YouTube Video:** <https://www.youtube.com/watch?v=6fx1W3pyq2s&feature=youtu.be>

## Soteria

Sponsored by Northrop Grumman

MEMBERS: Alex Aguilar, Adam Campbell, Nabi Habib, Sam Halabo, Bryan Kennedy, Riley Livers, Liam McCue, Mason Stark, Danny Tisnado, Dylan Van

ADVISORS: Ryan Debusk - Northrop Grumman, Professor Barry Dorr - SDSU, Dave Hendron - San Diego Sheriff's Department, Dr. Scott Shaffar - SDSU, Dean Shears - Northrop Grumman

**UAV Payload Deployment for Search and Rescue**

Team Soteria designed and manufactured a payload deployment for search and rescue teams. The goal of the payload is to be able to carry lightweight emergency supplies to remote locations with the use of the current Search and Rescue (SAR) drone, the DJI Mavic 2 Enterprise. The payload is lightweight, portable, and non-intrusive to the drone sensors. The attachment method is interchangeable, and the release mechanism is initiated through audio signals and can be done from any distance the drone can fly.

**Poster:** [electrical.sdsu.edu/designday2023/posters/project17-uavpayloaddeploy.pdf](https://electrical.sdsu.edu/designday2023/posters/project17-uavpayloaddeploy.pdf)

**YouTube Video:** [https://youtu.be/NQ4XH0D63\\_g](https://youtu.be/NQ4XH0D63_g)

## Team Bondi

Sponsored by Masimo

MEMBERS: Abdulaziz Alali, Jocelyn Arias, Zachary Conte, Brayan Lopez Corona, Chance Fugleseth, Jessica Gear, Braden Hooper, Hana Julazadeh, Thomas Trinh, Ryan Wilson

ADVISORS: Chris Cardenas - Masimo, Professor Barry Dorr - SDSU, Brendan Green - Masimo, Dr. Shaffar - SDSU, Kamyar Khorrami - Masimo, Glenn Pohly - Masimo, Pratul Singh - Masimo

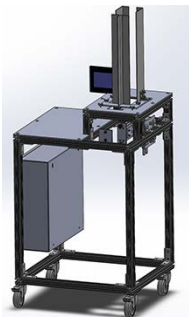
**Automated Pouch Opener/Presenter**

Masimo is a medical device company that manufactures 100 million medical devices each year and is in need of streamlining their current process of inserting adhesive sensors into pouches. To increase the production volume, speed, and accuracy, Team Bondi has designed an automated pouch opener/presenter for Masimo to implement into their facilities. The system uses a Programmable Logic Controller (PLC) and sensors to control the pneumatics in order to grab a pouch from a hopper and then opens and presents the pouch to an operator for sensor insert.

**Poster:** [electrical.sdsu.edu/designday2023/posters/project16-autopouch.pdf](https://electrical.sdsu.edu/designday2023/posters/project16-autopouch.pdf)

**YouTube Video:** <https://www.youtube.com/watch?v=dfdaieJGf6U>

**Team Maverick**

Sponsored by General Atomics

MEMBERS: Saja Allalao, Paul Baker, Andy Galvan, Ezra Garcia, Alex Johnson, Gregor Krzyminski, Sonny Pham, Ofek Suchard, James Winter, DJ Younkin

ADVISORS: Professor Barry Dorr - SDSU, David Putnam - General Atomics, Christopher Sam - General Atomics, Dr. Scott Shaffar - SDSU

**Automated Taxi / Parking Enabling Technology**

Team Maverick delivers a complex system for General Atomics's MQ-9A drone with their 1/10th scale drone with similar driving, steering, and brake systems utilizing the spiral design model that is capable of a high number of cycles, is low cost, easy to manufacture, and has high maneuverability. The drone incorporates GPS mapping through a UI to steer the drone to the target destination, taxiway line tracking, and object distance detection that brakes or slows depending on the distance detected of an object in view.

**Poster:** [electrical.sdsu.edu/designday2023/posters/project12-mq-9.pdf](https://electrical.sdsu.edu/designday2023/posters/project12-mq-9.pdf)

**YouTube Video:** <https://www.youtube.com/watch?v=1QZaHIE9hWg>

**Vulcan**

Sponsored by SDSU &amp; NASA

MEMBERS: Beqa Abulashvili, Jared Acosta, Kevin Breslin, Juan Levya Carrillo, Hunter Gavin, Leah Lafata, Dylan Lomas, Angelina Parker, Ian Phelps, Joshua Putris

ADVISORS: Professor Barry Dorr - SDSU, Dr. Scott Shaffar - SDSU

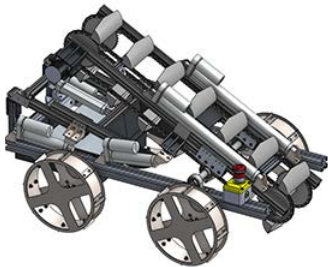
**NASA Artemis 2023 Lunabotics - Robotic Mining Challenge**

Team VULCAN is representing a joint Mechanical, Computer, and Electrical Engineering team from San Diego State University at the NASA Robotic Mining Competition Lunabotics 2023. The competition's goal aims to prototype a rover capable of delivery to the moon in order to excavate lunar regolith beneath its surface, serving NASA's Artemis Mission to the Moon. The rover will be capable of successfully completing a simulated mission of deployment to the moon to collect lunar regolith while avoiding obstacles and craters.

**Poster:** [electrical.sdsu.edu/designday2023/posters/project32-nasaartemis.pdf](https://electrical.sdsu.edu/designday2023/posters/project32-nasaartemis.pdf)

**YouTube Video:** <https://www.youtube.com/watch?v=p73T85imP2s>

# MECHANICAL ENGINEERING >>>

## All Brakes No Gas

Sponsored by Aztec Electric Racing

MEMBERS: Ryder Bullock, Sonya Loreda, Christian Lunt, Jack Muller, Henri Stephan, Nolan Zaayer

ADVISOR: Dr. Scott Shaffar - SDSU

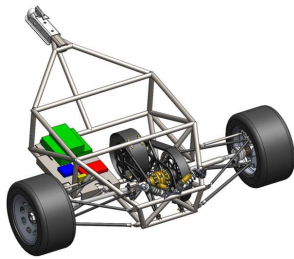

### Regenerative Braking System for An Electric Formula SAE Racecar

Every year, Aztec Electric Racing (AER) looks for ways to improve the performance of their Formula SAE Racecar. This year, the student-run club wanted to test a regenerative braking system to improve the car's efficiency and range. The purpose of this project was to quantify the power sent back through the system at a variety of speeds under regenerative braking. The system was developed as a testing trailer that attaches to the back of a vehicle and is a copy of the rear portion of the former 2022 AER racecar.

Poster: [mechanical.sdsu.edu/designday/posters/28.regenerative.brakes.pdf](https://mechanical.sdsu.edu/designday/posters/28.regenerative.brakes.pdf)

YouTube Video: <https://www.youtube.com/watch?v=KLqUkopPDIU>

## ChargeOne+

Sponsored by Aztec Electric Racing

MEMBERS: Rukaiya Doctor, Ethan Gao, Samantha Harris, William Randall

ADVISOR: Dr. Scott Shaffar - SDSU

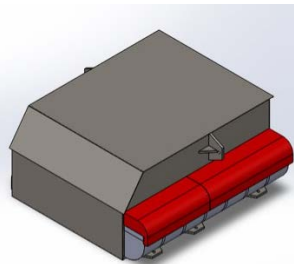

### Battery Box Design for an Electric Formula SAE Race Car

The Aztec Electric Racing team currently needs a battery box, or accumulator, which houses the battery cells and electrical components necessary for supplying the high voltage needs of an electric race car. It must have an efficient air-cooling system to keep the batteries and electrical components at the optimal operating temperature while running. Our team's project is to design, test, and build an accumulator that will do so while staying within the regulations set by the Formula Society of Automotive Engineers

Poster: [mechanical.sdsu.edu/designday/posters/27.batterybox.pdf](https://mechanical.sdsu.edu/designday/posters/27.batterybox.pdf)

YouTube Video: <https://www.youtube.com/watch?v=Zlq2R2By4-c>

## Diabeating Diabetes

Sponsored by Dexcom

MEMBERS: Karen Lopez-Mendez, Lindsay MacLeod, Josemario Manansala, Erin Moore, Miguel Rodriguez

ADVISORS: Lenny Barbod - Dexcom, Dr. Scott Shaffar - SDSU, Max Spiegelhoff - Dexcom

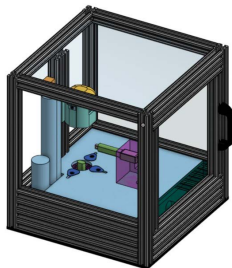

### Automated Applicator Reliability Test Fixture

Team DiaBEATING Diabetes designed, developed, tested, and produced an automated verification test fixture for one of Dexcom's newest, unreleased, products in their diabetes healthcare line. This automated fixture reduces time and cost of testing while simulating the conditions the device will experience in its lifetime. The test fixture puts the device through 100 cycles of testing and records and displays the number of test cycles performed while maintaining user safety and integrity of the device being tested.

Poster: [mechanical.sdsu.edu/designday/posters/4.automatedapplicatorreliability.pdf](https://mechanical.sdsu.edu/designday/posters/4.automatedapplicatorreliability.pdf)

YouTube Video: <https://www.youtube.com/watch?v=HfgXJctxHRw>



## Electric Makos

Sponsored by Aztec Baja SAE

MEMBERS: Kyle Bona, Stephen Drummy, Marcus Good, Andrew Ruff, Oskar Salminen

ADVISOR: Dr. Scott Shaffar - SDSU

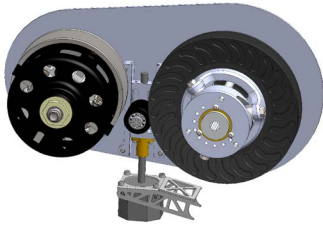

### Electro-Mechanical Continuously Variable Transmission

Aztec Baja's SAE vehicle competes each year in the SAE Baja collegiate design series, where various aspects of the vehicle are tested. The car utilizes a continuously variable transmission (CVT), which is prone to shift issues in racing conditions. Team Electric Makos has designed and manufactured an electro-mechanical transmission assist component (EMTAC) to solve this problem. The EMTAC system influences shift ratio by applying tension to the CVT belt.

Poster: [mechanical.sdsu.edu/designday/posters/36.electromechanicalcontinuous.pdf](http://mechanical.sdsu.edu/designday/posters/36.electromechanicalcontinuous.pdf)

YouTube Video: <https://www.youtube.com/watch?v=sXpWdGg-oXA>

## Hephaestus

Sponsored by SDSU Mechanical Engineering Department

MEMBERS: Andres Cardenas, Dalaney Conte, Bryce Horton, Mathew Tivey, Caroline Yu

ADVISORS: Dr. John Abraham - SDSU, Jill Esler - Hi-Z Technologies, Dr. Scott Shaffar - SDSU

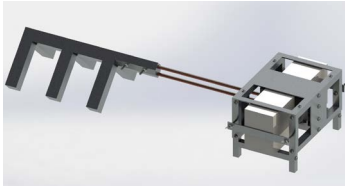

### Thermoelectric Power Generator

Team Hephaestus was tasked by SDSU Mechanical Engineering Department's Chair, Dr. Abraham, to create a sustainable power generator through the use of Thermoelectric Devices. The team has crafted a product that will use the high temperatures of a traditional campfire to distribute the heat into two Thermoelectric Modules through a heat exchanger. The TEMs will be used alongside two Cooling Units to produce a suitable temperature difference to charge a 14.8 V battery, which can charge a slew of electronic devices.

Poster: [mechanical.sdsu.edu/designday/posters/34.applicationsofthermoelectric.pdf](http://mechanical.sdsu.edu/designday/posters/34.applicationsofthermoelectric.pdf)

YouTube Video: <https://www.youtube.com/watch?v=EQu7QB8p3vQ>

## Hot End Aeronautics

Sponsored by SDSU and Erika Binder, Alumni - CSULA

MEMBERS: Alexandre Balensi, Alexander Brown, Josh Gipson, Henos Hussien, Matt Owens

ADVISORS: Dr. Charles Norris, Dr. Scott Shaffar - SDSU



### 3D Printed Aircraft Competition

The Hot End Aeronautics team has designed and manufactured a 3D printed fixed-wing aircraft with the goal of prolonged flight to compete in the 3D Printed Aircraft Competition (3DPAC) hosted by California State University, Los Angeles. The project guidelines call for an aircraft that can glide the longest with a safe propulsion method for 8 seconds. All components must be 3D printed other than the electronics within the aircraft. The aircraft shall be designed as a glider in order to perform competitively.

Poster: [mechanical.sdsu.edu/designday/posters/21.hotendaeronautics.pdf](http://mechanical.sdsu.edu/designday/posters/21.hotendaeronautics.pdf)

YouTube Video: <https://www.youtube.com/watch?v=03ibOjmEMzI>

**Mirror Mirror**

Sponsored by ASML

MEMBERS: Hunter Atchley, Brenden Funke, Jorge Pineda, Andrew Preisler, Aaron Ramirez

ADVISORS: Joe Bendik - ASML, Dr. Scott Shaffar - SDSU

**Multilayer Mirror Sample Holder with Cooling**

ASML develops extreme ultraviolet, lithography light sources using laser-produced, plasma technology. A vacuum, test chamber used to develop new technologies such as heating and cooling elements, optimized gas mixtures, and new multilayer mirror (MLM) coatings can be problematic as temperatures reach up to 300°C during operation. In order to protect the samples, Team Mirror Mirror was tasked with the design, build, and testing of a mirror holder capable of cooling samples below 80°C.

**Poster:** [mechanical.sdsu.edu/designday/posters/multilayermirrorposter.pdf](https://mechanical.sdsu.edu/designday/posters/multilayermirrorposter.pdf)

**YouTube Video:** <https://www.youtube.com/watch?v=015mb6PVe8M>

**Pacific Turbines**

Sponsored by SDSU Mechanical Engineering Department

MEMBERS: Carson Campbell, Kelsie Dang, Isaiah Gentry, Angel Mora, Franco Ojeda

ADVISORS: Dr. Asfaw Beyene - SDSU, Dr. Scott Shaffar - SDSU

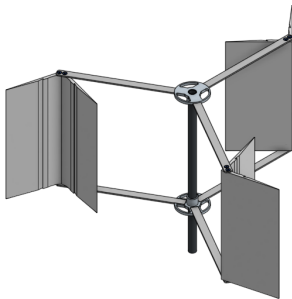
**Design and Test of Savonius Wind Turbines Equipped with Flexible Blades**

A Vertical Axis Wind Turbine (VAWT) has its axis of rotation perpendicular to the wind streamlines, i.e., vertical to the ground. Thus, it has a drag side which rotates against the wind, and the lift side which rotates in the direction of the wind. In this project, the team built a VAWT in such a way the flexibility of the blade reduces the drag on the upstream side while it increases the lift on the downstream side. The task of this project is to compare the efficiency of traditional rigid blades to new flexible blades for VAWTs.

**Poster:** [mechanical.sdsu.edu/designday/posters/26.designandtestofsavonius.pdf](https://mechanical.sdsu.edu/designday/posters/26.designandtestofsavonius.pdf)

**YouTube Video:** <https://www.youtube.com/watch?v=frU98unFEGk>

**Plane and Not-So-Simple**

Sponsored by SDSU and Erika Binder, Alumni - CSULA

MEMBERS: Drake Campo, Oscar Correa, Xavier Major, Ben Saldana, Kenton Williams

ADVISORS: Dr. Charles Norrism, Dr. Scott Shaffar - SDSU

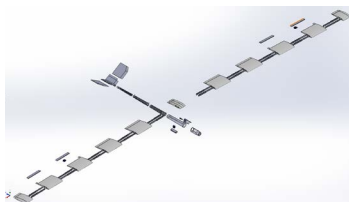
**3D Printed Aircraft Competition**

This team performed research, analysis, and testing to design and manufacture a fully 3D printed RC aircraft with the purpose of winning both the Most Innovative Design and Longest Duration of Flight awards in the fixed-wing category at the 3D Printed Aircraft Competition to be held in May at Cal State Los Angeles. All lifting surfaces and aircraft components must be 3D printed, except for electronics, the propeller, and some hardware. The aircraft is allowed to be powered for only 8 secs and must fly under a 30 ft altitude.

**Poster:** [mechanical.sdsu.edu/designday/posters/20.planeandnotsosimple.pdf](https://mechanical.sdsu.edu/designday/posters/20.planeandnotsosimple.pdf)

**YouTube Video:** <https://www.youtube.com/watch?v=tVUbqSb9Wr0>



## Proplane

Sponsored by SDSU Mechanical Engineering Department

MEMBERS: Steven Bach, Elijah Roa, Kyle Serbin, Larson Sevilla, Diego Tres

ADVISORS: Dr. Fletcher Miller - SDSU, Dr. Scott Shaffar - SDSU

**PROPLANE**  
Sustainable Aviation Solutions

### NASA Blue Skies Clean Aviation Energy Competition

This challenge is sponsored by NASA with the objective of finding new clean energy sources for future commercial aviation. The team researched, selected and analyzed an alternative fuel for aviation that will reduce soot production along with pollutant emissions. The fuel selected is propane. To support this work, a propane combustion chamber will be utilized to test soot output and carbon emissions in which the data will reflect the teams energy source chosen for NASA.

**Poster:** [mechanical.sdsu.edu/designday/posters/18.nasagatewaystoblueskies.pdf](https://mechanical.sdsu.edu/designday/posters/18.nasagatewaystoblueskies.pdf)

**YouTube Video:** <https://www.youtube.com/watch?v=EtuG7ln7D7o>

## Reapers

Sponsored by General Atomics

MEMBERS: John Callaway, Brendan Le Veille, Vincent Rios-Austin, Brennan Rodenburg, Lincoln Tadewald

ADVISORS: Mr. David Putnam - General Atomics, Dr. Scott Shaffer - SDSU

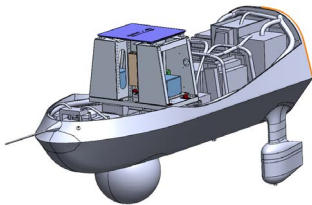

### Airborne Payload Enclosure

The team completed research, design, analysis, and manufacturing of an avionics rack for General Atomic's MQ-9 Reaper Drone. The avionics rack will support a Low Earth Orbit (LEO) antenna, modular Line Replaceable Unit (LRU) system and have an active cooling system. The avionics rack was designed to fit in the space of the legacy geostationary antenna being replaced by the LEO antenna.

**Poster:** [mechanical.sdsu.edu/designday/posters/11.airbornepayloadenclosure.pdf](https://mechanical.sdsu.edu/designday/posters/11.airbornepayloadenclosure.pdf)

**YouTube Video:** <https://www.youtube.com/watch?v=s2hN-Qm8vjk>

## Recycruncher

Sponsored by Aous Mohammad, Independent Entrepreneur

MEMBERS: Brendan Denney, Brady Lopez, Mateo Marquez, Zachary Morgan, Melissa Owens

ADVISOR: Dr. Scott Shaffar - SDSU



### Recycle Cruncher

This product will eliminate recycling issues by automatically crunching a can or bottle inside the unit to a significantly smaller size utilizing an internal gear motor system. This unit will allow the user to place the product on the side of a bin used to collect recycling. Upon placing the standard 12 oz can or 16.9 oz water bottle into the cruncher, the unit will crunch the recycling without any further input from the user. This creates a hassle free method of recycling for all audience types.

**Poster:** [mechanical.sdsu.edu/designday/posters/9.recycruncherautomatedcanandbottle.pdf](https://mechanical.sdsu.edu/designday/posters/9.recycruncherautomatedcanandbottle.pdf)

**YouTube Video:** <https://www.youtube.com/watch?v=FwOS4w9fLNq>



**Spin It To Win It**

Sponsored by SDSU Mechanical Engineering Department

MEMBERS: Nicholas Agtual, Madison Anderson, Dylan Lawrence, Kyle Mesch, Derek Nunotani

ADVISORS: Dr. Scott Shaffar - SDSU, Dr. George Youssef- SDSU

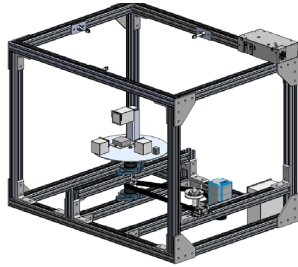
**Rotating Disk Cellular Solid Testing Apparatus**

Current mechanical testing for materials used in impact mitigation neglects the effect of rotational acceleration, a common factor in concussions. The objective is to build a test apparatus capable of spinning elastomeric foam samples at variable speeds up to 3000 RPM based on the experimentalist command while capturing digital images of the deformed surfaces. Ex-situ digital image correlation will be used to quantify the in-plane strain components, assessing the effects of rotational acceleration on the foam efficacy.

**Poster:** [mechanical.sdsu.edu/designday/posters/21.rotatingdiskcellular.pdf](https://mechanical.sdsu.edu/designday/posters/21.rotatingdiskcellular.pdf)

**YouTube Video:** <https://www.youtube.com/watch?v=xhXApzluJ-w>

**Sun Tilt**

Sponsored by SDSU Mechanical Engineering Department

MEMBERS: Patrick Anderson, Marco Maganuco, Brenden Patch, Andrea Renteria, Christine Tan

ADVISORS: Dr. Asfaw Beyene - SDSU, Dr. Scott Shaffar - SDSU

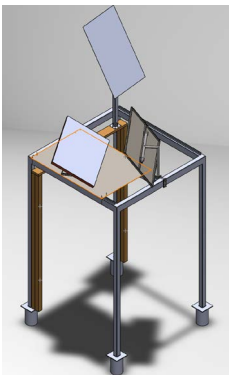
**GPS Controlled Solar Panels with Reflectors, Data Collection**

The goal of this project was to compare the performance of a GPS solar panel to a stationary panel with a reflector. This was achieved by creating a platform support system for the solar panels and reflector as well as designing the reflector to amplify the sunlight onto the stationary solar panel. The team manufactured a platform to raise the GPS solar tracking system above ground, which will allow the tracking system to position the panel perpendicular to the sun to obtain maximum sunlight and avoid shadows. Additionally, the team manufactured a reflector that can be manually adjusted to maximize energy collection. The successful completion of this project will provide important insights to solar energy research and help revolutionize solar energy production and implementation.

**Poster:** [mechanical.sdsu.edu/designday/posters/25gpscontrolledsolar.pdf](https://mechanical.sdsu.edu/designday/posters/25gpscontrolledsolar.pdf)

**YouTube Video:** <https://www.youtube.com/watch?v=KlbVIJLBr2E>

**Team Benchwarmers**

Sponsored by Quality of Life Plus

MEMBERS: Nyah Brooks, Courtney Earley, Elias Malachi Enguancho, Sam Griffith, Cody Pennefather

ADVISORS: Scott Huyvaert - Quality of Life Plus, Dr. Scott Shaffar - SDSU, SSG Christopher Walker - US Army Retired

**Adaptive and Integrated Woodworking Workbench**

SSG Christopher Walker experienced the loss of both arms, his left leg, and many other injuries from an improvised explosive device in 2012. After recovery, he picked up woodworking but after nine years, his setup still does not accommodate a wheelchair amongst other limitations. To increase safety, capability, quality, and speed, Team Benchwarmers created: a height-adjustable bench that allows sitting and standing, shelving for better tool access, a crane lift to move material, and an arch arm to safely manage cords.

**Poster:** [mechanical.sdsu.edu/designday/posters/30.adaptiveandintegrated.pdf](https://mechanical.sdsu.edu/designday/posters/30.adaptiveandintegrated.pdf)

**YouTube Video:** <https://www.youtube.com/watch?v=PdaglfeCPHc>



**Team Spray 'n Prey**

Sponsored by National Security Innovation Network &amp; US Air Force

MEMBERS: Eric Apgar, Travus Clark, Hernan Velazquez Munoz, Daniel Murillo, Joshua Pasco

ADVISOR: Dr. Scott Shaffar - SDSU

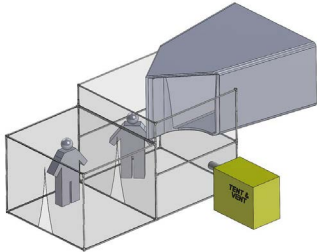
**USAF B-1B Biohazard Compliant Nacelle Finishing Structure**

This project provides the Ellsworth USAF with a portable/reusable bioengineering compliant finishing structure used for the nacelles of the B-1B aircraft. This ready-to-use product solution eliminates a major safety hazard to the USAF team. Key features of the finishing structure include; collapsibility, height variability and a separate enclosed decontamination room. The PVC structure is easy to procure, cost effective and architecturally adaptive for other aircraft.

**Poster:** [mechanical.sdsu.edu/designday/posters/7.usafb1bbiohazard.pdf](https://mechanical.sdsu.edu/designday/posters/7.usafb1bbiohazard.pdf)

**YouTube Video:** <https://www.youtube.com/watch?v=UMMA51HbgbE>

**Team Sprinter**

Sponsored by SDSU Mechanical Engineering Department

MEMBERS: Patrick Cruz, Brandon Nevares, Justin Palisoc, Khoa Tran, Francisco Zazueta Felix

ADVISORS: Ifeanyi Donald Olumor - Consultant, Dr. Scott Shaffar - SDSU, Dr. Elisa Torresani - SDSU

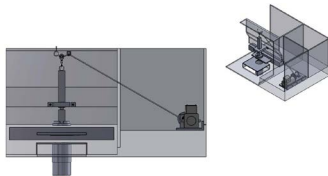
**Press Assisted Binder Jetting**

Our team's objective was to design and develop a removable pressure applicator system that could be installed internally into the largest binder jetting printer in the Powder Technology Laboratory at SDSU. The pressure applicator system includes removable weights to vary the pressure in between green body layers as a component is printed in order to achieve a decrease in the overall porosity of the final printed component.

**Poster:** [mechanical.sdsu.edu/designday/posters/23.pressassistedbinder.pdf](https://mechanical.sdsu.edu/designday/posters/23.pressassistedbinder.pdf)

**YouTube Video:** <https://www.youtube.com/watch?v=CfYu6fHaYcQ>

**Turbine Titans**

Sponsored by Solar Turbines

MEMBERS: Manuel Aldana, Kamron Arvand, Aidan Donaghe, Eddie Greer, Carlos Enrique Neyra

ADVISORS: Jordan Ferreira - Solar Turbines, Gregor Robertson - Solar Turbines, Dr. Scott Shaffar - SDSU

**Enclosure Pressure Relief for Industrial Applications**

The team was tasked with designing, manufacturing, and testing a mechanical solution that would allow technicians inspecting Solar Turbines industrial gas turbine packages to depressurize the turbine's equipment enclosure while the turbine is operating. The chosen solution is a leverage bar which a technician would use to open the enclosure door partially in positive and negative pressure differentials to allow pressure to equalize. The team then designed and manufactured a test rig for the device to collect data and verify the bar's function.

**Poster:** [mechanical.sdsu.edu/designday/posters/26.designandtestofsavonius.pdf](https://mechanical.sdsu.edu/designday/posters/26.designandtestofsavonius.pdf)

**YouTube Video:** <https://www.youtube.com/watch?v=VPjbtA9Tso>

MEMBERS: Luis Aldrete, Joel Grieshaber, Kolton Nevins, Gaven Obrecht, Alan Reyes

ADVISORS: Mark Bauckman - Fluidra, Walter Coe - Fluidra, Dr. Scott Shaffar - SDSU

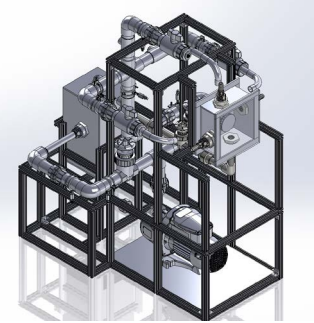

### Hydro Turbine Dynamometer

Fluidra is the largest manufacturer of pool and spa equipment. Fluidra's current pool cleaning robot has a turbine and gear system to provide mechanical power to drive the wheels only. The team is tasked to add an electrical generator to the system to power low voltage devices. With water flowing at 4 gpm and 30 psi, the robot shall produce 20 W of power and no more than 30 V. To achieve this, the team has developed a testing apparatus to determine the most efficient way to convert fluid flow into electricity.

**Poster:** [mechanical.sdsu.edu/designday/posters/10.submersibleelectricgenerator.pdf](https://mechanical.sdsu.edu/designday/posters/10.submersibleelectricgenerator.pdf)

**YouTube Video:** <https://www.youtube.com/watch?v=Pg9yQWxmek0>